



**M/DN<sup>®</sup> Femoral  
Interlocking  
& Recon Nail  
Intramedullary  
Fixation Surgical  
Technique**





## **Surgical Techniques for Fixation of Femoral Fractures with an M/DN Nail**

## **Table of Contents**

Introduction	2
Indications	3
Preoperative Planning	4
Patient Positioning and Radiographic Control	4
Reduction	5
Incision and Exposure	5
Creating the Entry Portal	5
Guide Wire Placement and Reaming	6
Nail Insertion	8
Interlocking Application	10
Recon Application	10
Proximal Locking	11
Interlocking Application	11
Recon Application	13
End Cap Placement	14
Distal Locking	14
Technique for Using the Freehand Targeting Device	14
Closure and Postoperative Care	17
Extraction	17
Instrument Case Options	18

### Introduction

Closed intramedullary nailing has long been a common method of treating noncomminuted fractures of the femur and tibia. The interlocking nail has extended the indications of closed intramedullary nailing to include comminuted fractures, fractures with bone loss, and proximal and distal fractures of the femur.

The multi-point fixation provided by the cross-section of the *M/DN*® Nail makes it appropriate for use unlocked (Fig. A) as well as locked in either the dynamic (Fig. B) or static mode (Fig. C). It also makes it appropriate for reamed or unreamed applications.

The successful use of any intramedullary nail is technically demanding. Close attention to positioning, reduction, rod placement, and insertion of the proximal and distal locking screws is mandatory.

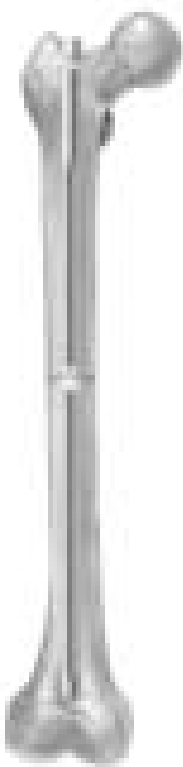

Fig A

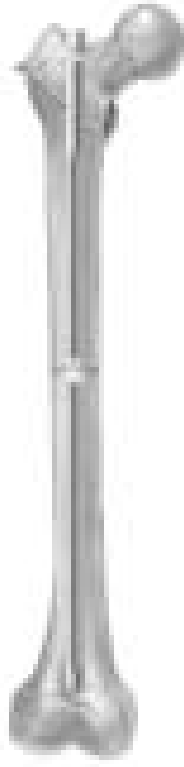

Fig B

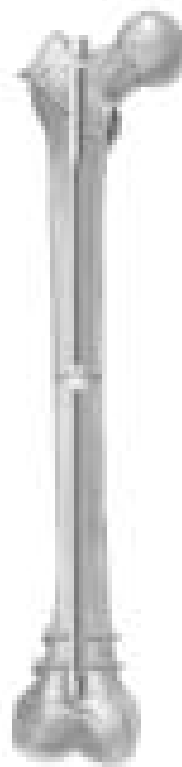

Fig C

## Indications

The *M/DN* femoral nail is indicated for use in a variety of femoral fractures (Fig. 1), such as:

- A. Comminuted fractures
- B. Segmental fractures
- C. Fractures with bone loss
- D. Proximal and distal fractures
- E. Nonunions
- F. Subtrochanteric fractures
- G. Intertrochanteric fractures

Fig 1

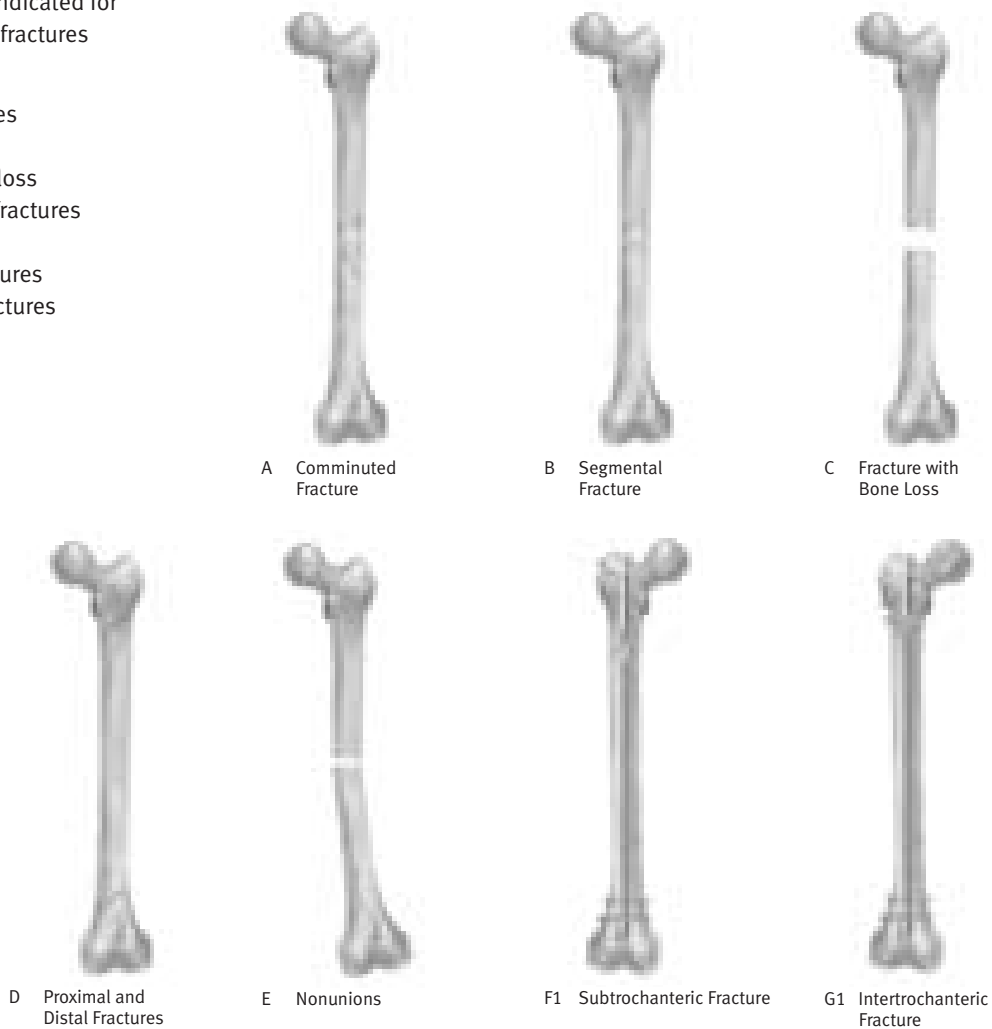

## Surgical Technique for M/DN Femoral Nail Fixation (Interlocking and Recon Applications)

The M/DN Femoral Nail is designed for varied use. A single nail can be used for both right and left standard interlocking or recon procedures. The femoral nail is available in the most commonly used sizes. These nails range in diameters from 8.0mm to 16.0mm and lengths from 24cm to 50cm.

### Preoperative Planning

Proper preoperative planning is essential to successful interlocking or recon nailing of the femur. To determine the appropriate nail size, an ossimeter, roentgenogram templates, and an x-ray film of the unaffected extremity are necessary for determining canal size at the isthmus and for measuring the length of the femur to aid in determining nail length.

The IM Nail Length Gauge or Harris/Galante Bulb-Tip Guide Wires (Sounds), available in diameters from 10mm-17mm, can be used as alternate techniques to determine nail diameter and length.

X-rays taken at a 36-inch distance from the x-ray source result in 10-15 percent magnification of bone. The ossimeter has both an actual size scale and one that takes into account this magnification. It should be used routinely to determine nail diameter and length.

The proper length of nail should extend from the tip of the greater trochanter to the epiphyseal scar. The diameter of the femoral nail should match the isthmus in the lateral x-ray projection.

The surgeon should review the x-ray to assure that there are no unusual anatomic variations.

### Patient Positioning and Radiographic Control

The patient may be placed in either the supine or the lateral decubitus position (Fig. 2). In multiple trauma patients, the supine position may be used for easier access to the airways as well as to facilitate the treatment of other injuries. The supine position also facilitates fracture reduction and rotational alignment of the femur. The disadvantage to the supine position is that it impairs access to the tip of the greater trochanter for insertion of the nail.

**It is essential to obtain excellent A/P and lateral images of the femoral head and neck prior to beginning the surgery regardless of which patient position is used.**

The use of image intensification or other x-ray imaging is required. The image intensifier should be sterile-draped and may be positioned from either the contralateral or ipsilateral side of the operating table. Confirm visualization of the hip as well as the shaft of the femur using image intensification before prepping and draping. Bend the patient's torso away from the affected extremity to improve access to the greater trochanter. If access to the greater trochanter is still inadequate, adduct the affected leg. However, to achieve proper alignment of the fracture, this adducted position must be corrected prior to insertion of the nail.

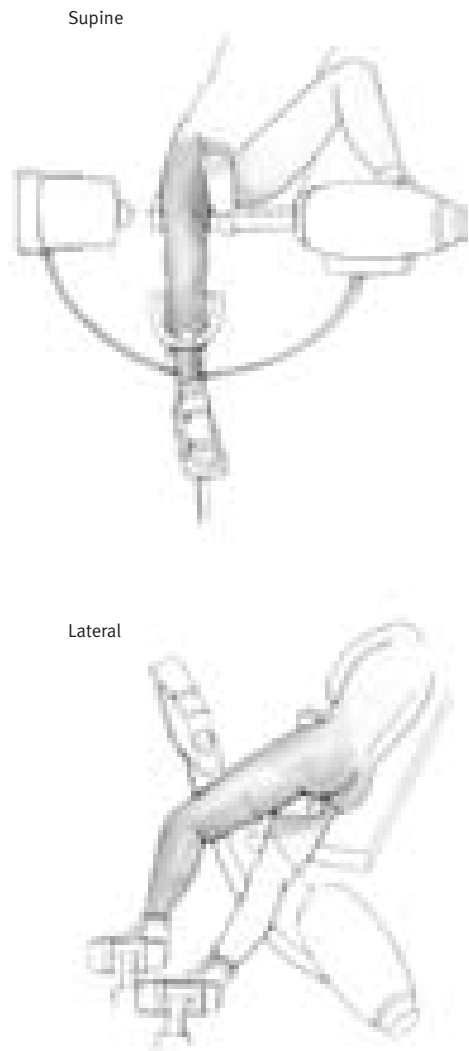

Fig 2. Supine and lateral decubitus positions.

### Reduction

It is important to reduce the fracture before beginning the surgical procedure.

### Incision and Exposure

Begin the skin incision 1cm proximal to the greater trochanter and carry it proximally about 5cm in line with the gluteus maximus muscle (Fig. 3). A larger incision may be desired for obese patients. Split the fascia of the gluteus maximus in line with its fibers. Identify the subfascial plane of the gluteus medius, and palpate the posterior tip of the greater trochanter. Retract the muscles to facilitate visualization of the piriformis fossa.

This may be difficult in the obese patient, especially if flexion causes the tip of the trochanter to lie against the ilium. Positioning techniques used to expose the tip of the trochanter include adduction of the leg and positioning of the patient's torso away from the affected extremity.

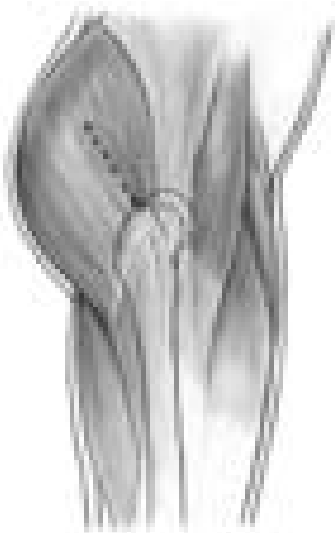

Fig 3

### Creating the Entry Portal

Locating the correct entry portal in the piriformis fossa is extremely important. For the interlocking procedure, place the Femoral Awl at the piriformis fossa (Fig. 4) and check its position with A/P and lateral views.

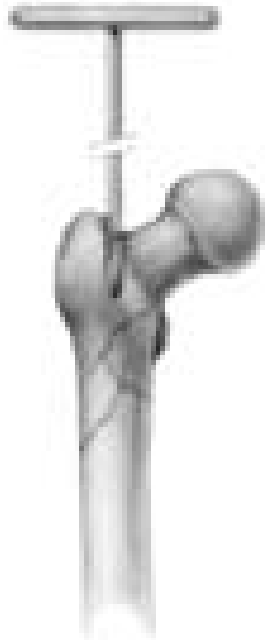

Fig 4

For the recon procedure, place the Femoral Awl in the anterior portion of the piriformis fossa approximately 5mm anterior to the position you would choose when doing a standard femoral nailing (Fig. 5). This will facilitate screw placement in the center of the femoral neck.

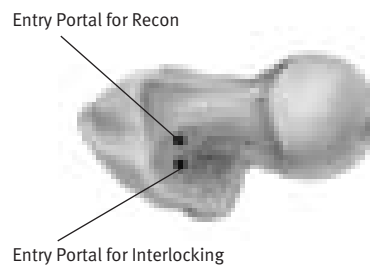

Fig 5

Check the position of the awl with both A/P and lateral images before creating the portal. On the A/P image, the awl should lie at the base of the femoral neck adjacent to the greater trochanter. On the lateral view, it should be oriented just posterior to the center of the femoral neck. When the correct position is achieved, rotate the awl to create the entry portal for the Ball-Tip Guide Wire.

If using the Long Cannulated Awl, the 3.0mm Ball-Tip Guide Wire can be inserted through the Awl.

An alternative method is to insert a 3.2mm Steinmann Pin into the piriformis fossa while checking the position with A/P and lateral image intensification. The Steinmann Pin must lie at the base of the femoral neck just medial to the greater trochanter on the A/P view, and oriented just posterior to the center of the femoral neck on the lateral view. Seat the Steinmann Pin well into the proximal femur and use the optional 9mm Trochanteric Reamer to create the entry portal (Fig. 6).

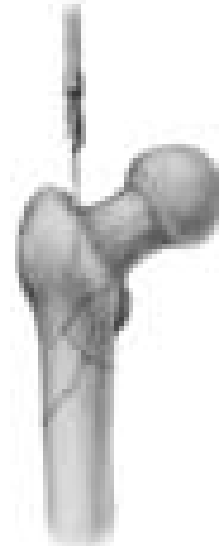

Fig 6

## Guide Wire Placement and Reaming

### Conventional Guide Wire/Exchange Tube Technique

Attach the 3.0mm Ball-Tip Guide Wire to the Wire-Grip T-Handle (Fig. 7) and tighten. The Ball-Tip Guide Wire may also be described as a Bulb-Tip or Bullet-Tip Guide Wire. To aid in manipulation, bend the tip of the Guide Wire at about a 10° angle/5cm from the end. Insert the Guide Wire through the entry hole and manipulate it down the proximal femur. At the fracture site, manipulate the Guide Wire under C-arm control (Fig. 8). Once in the distal canal, pass the wire to its final position in the epiphyseal scar (Fig. 9). 3.

**CAUTION: If the guide wire is bent shorter than 5cm from the end of the wire and/or more than 10 degrees it may be difficult to remove from the nail. If the wire becomes lodged inside the nail, utilize the WIRE GRIP T-HANDLE and mallet to remove the guide wire from the nail.**

If reduction of the abducted and flexed hip is difficult, place pressure on the anterior aspect of the proximal fragment either with the hand or directly with an instrument.

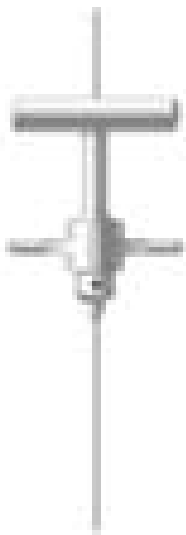

Fig 7

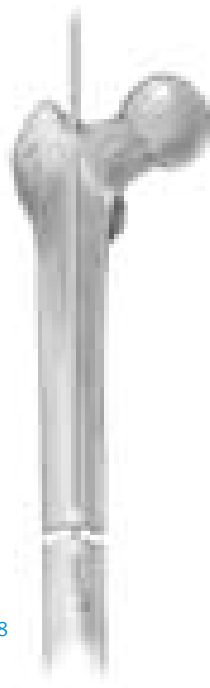

Fig 8

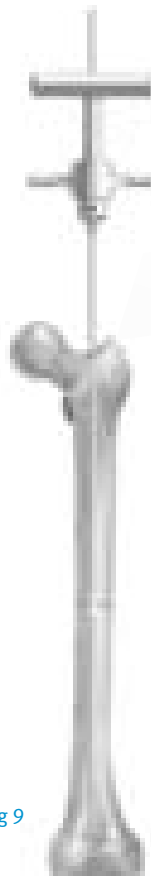

Fig 9

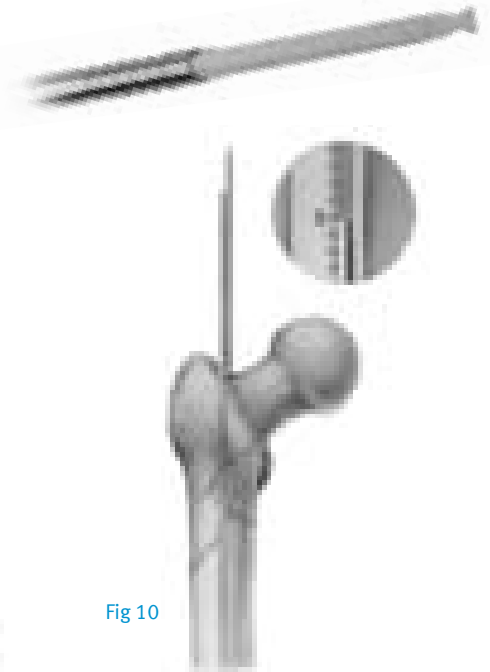

Fig 10

The Reduction Finger can be used to assist in femoral fracture reduction. To use the Reduction Finger, advance the Guide Wire and ream the proximal segment. Pass the Reduction Finger over the Ball-Tip Guide Wire. Manipulate the fracture externally while using the Reduction Finger internally to aid in fracture reduction. Once the Ball-Tip Guide Wire has passed through the fracture site, the Ball-Tip Guide Wire is advanced to epiphyseal scar. If the Ball-Tip Guide Wire can not advance through the fracture site, the ball tip of the Guide Wire should be bent slightly and then reinserted to aid in internal reduction.

Determine the proper nail length by placing a second guide wire of equal length at the greater trochanter. The length of the wire that is not overlapping is the correct nail length (Fig. 10).

The 50cm Ruler or ossimeter may be used for an accurate measurement.

Another way to measure the length is to use the C-arm to position the 0 mark on the metal ruler at the tip of the trochanter. Then read the correct length at the epiphyseal scar directly off the metal ruler.

Alternatively, the IM Nail Length Gauge can be used to measure the appropriate IM Nail length through measurement of one 100cm guide wire. To use, place a 100cm Guide Wire down the medullary canal. Slide the IM Nail Length Gauge over the Guide Wire, ensuring that the distal portion of the gauge is resting on the piriformis fossa in order to determine correct nail length. Nail length is determined by noting the location of the remaining Guide Wire and reading the Nail Length Gauge at that particular location. If the length indicated is between two available nail sizes, it is recommended that the shorter nail be chosen.

**NOTE: Nail Length Gauge can only be used with 100cm Guide Wire.**

Remove the Wire-Grip T-Handle, and place an intramedullary reamer over the guide wire. The *Pressure Sentinel*® Intramedullary Reaming System is a system of one-piece reamers ranging in size from 5mm diameter to 27mm diameter in half millimeter increments. Each reamer is composed of a fluted reamer head, a shaft and a quick-connect drive end. The quick-connect end can be connected to a manual or powered driver. The width of the isthmus of the medullary canal is determined by preoperative x-ray examination. The instrument with the smallest possible diameter is used for initial reaming into the medullary canal. Reamers with a diameter of 5mm to 7.5mm use a 2.4mm Ball-Tip Guide Wire while reamers with a diameter of 8mm to 27mm use a 3.0mm Ball-Tip Guide Wire. As reaming continues, the reamer size should be increased by 0.5mm or 1.0mm increments until an opening of the desired size is obtained (Fig. 11).



Fig 11

**NOTE:** To avoid reamer lodging during use, reaming should be immediately stopped and the reamer retracted when there is too much resistance. If the reamer becomes lodged, stop reaming immediately. Reverse the direction of rotation of the handpiece and back the reamer out of the canal. The reamer can also be extracted by snapping the T-Handle Extractor onto the reamer end and then gently tapping the extractor with a small mallet or hammer.

**CAUTION:** Excessive blows to the T-Handle Extractor may damage the reamer or the extractor.

**NOTE:** The proximal diameter of the 8mm and 9mm M/DN Femoral Nail is 12mm. Therefore, over ream the proximal femur to 13mm for these nail diameters. The proximal diameter of the 10mm, 11mm, and 12mm M/DN Femoral Nail is 13mm. Therefore, over ream the proximal femur to just below the level of the lesser trochanter to 14mm for these nail diameters.

**NOTE:** If the GUIDE WIRE becomes lodged within the reamer, use the WIRE GRIP T-Handle to push the GUIDE WIRE back into the IM canal.

## New Guide Wire Technique Option

If using a Ball-Tip Guide Wire that does NOT have a gold coated end OR if using a nail less than 10mm:

When the reaming is complete and the final measurements are made, insert the plastic Exchange Tube over the Ball-Tip Guide Wire. Remove the Ball-Tip Guide Wire, and insert a Smooth Guide Wire (Fig. 12).

If using a Ball-Tip Guide Wire that DOES have a gold coated end and if using a nail equal to or greater than 10mm:

The Ball-Tip Guide Wire can remain in place. It is **NOT NECESSARY** to exchange the Ball-Tip Guide Wire for a Smooth Guide Wire. **WARNING:** If you are using a Ball-Tip Guide Wire without a gold-coated end, use the exchange tube technique as the regular Ball-Tip Guide Wire will not pass through the nail.

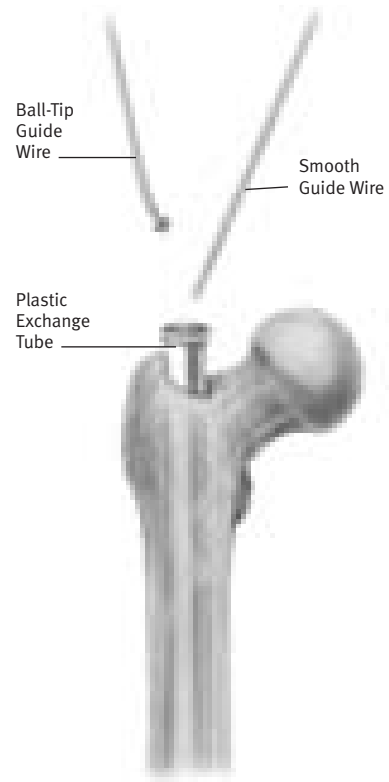

Fig 12

### Nail Insertion

Insert the appropriate Femoral Guide Barrel into the Femoral Proximal Guide. There are two different Femoral Guide Barrels (Fig. 13); one is for a right interlocking or left recon nail, while the other is for left interlocking or right recon nail. **It is extremely important to use the correct barrel for the intended procedure.** The Femoral Guide Barrel will help ensure the proper anteversion for nail insertion. The barrel will snap into place when fully inserted.

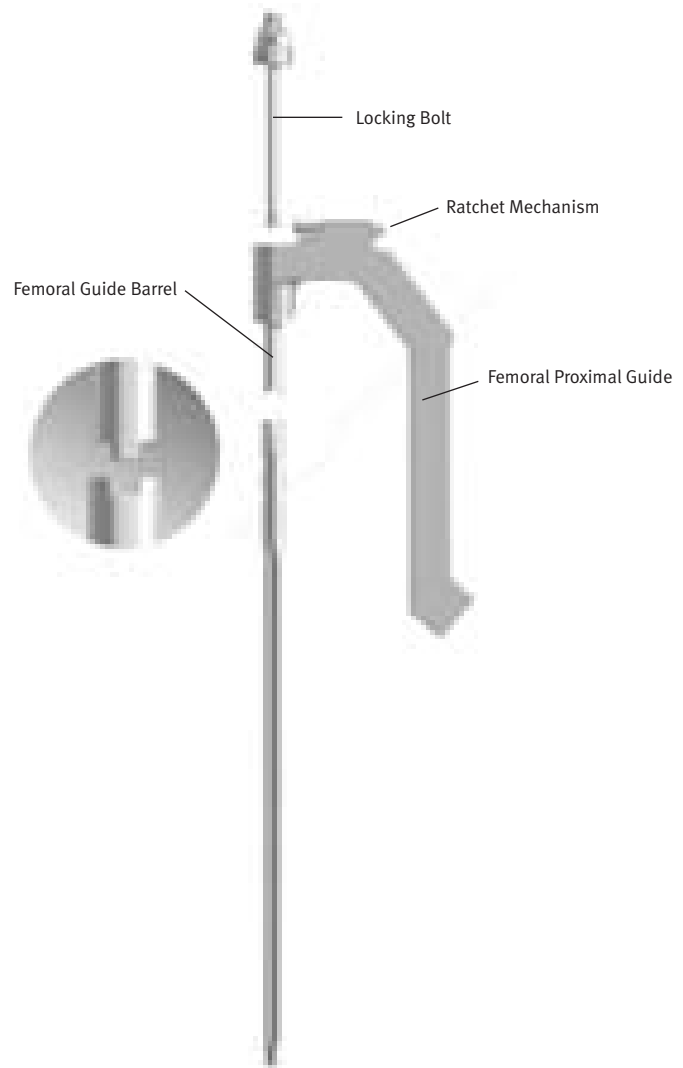

Fig 13

Attach the selected nail to the Femoral Proximal Guide (Table 1). Lift and turn the ratchet lever 90 degrees to open the ratchet mechanism of the guide. Insert the Locking Bolt through the barrel of the guide (Fig. 14).

Lift and turn the ratchet lever 90 degrees to close the ratchet mechanism, and use the Pin Wrench to tighten the Locking Bolt into the proximal end of the nail (Fig. 15). A keyway in the proximal end of the nail will help ensure proper alignment (Fig. 16). The ratchet mechanism will prevent the Locking Bolt from loosening during insertion of the nail.

**NOTE: If the ratchet mechanism of the Femoral Proximal Guide does not operate freely, it may be necessary to disassemble, clean, and reassemble the mechanism. If the ratchet mechanism becomes inoperative, it may be removed. The assembly will still function; however, the Locking Bolt may loosen during the procedure.**

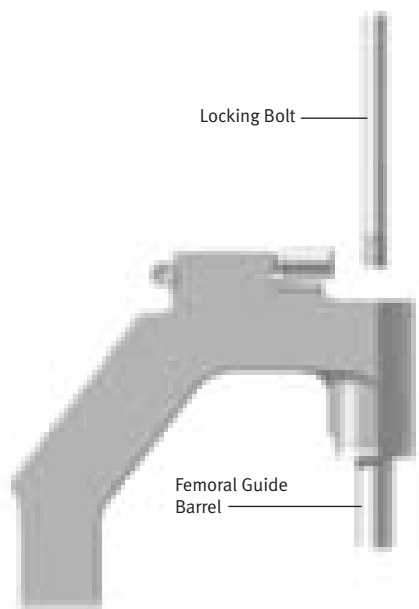
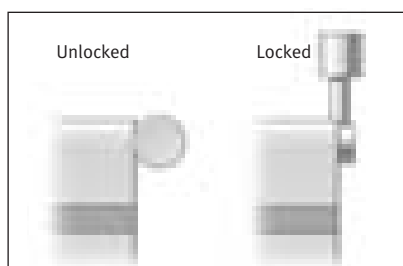

Fig 14

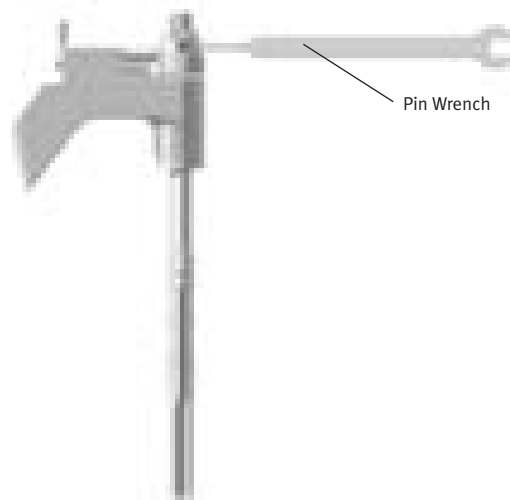

Fig 15

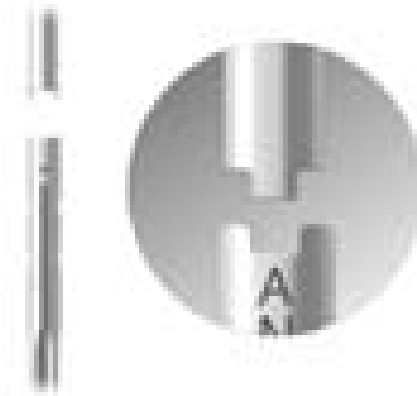

Fig 16

Table 1. M/DN Femoral Recon Nails Expanded Set

Nail Length (cm)	Nail Diameter (mm)									
	8	9	10	11	12	13	14	15	16	
24	•	•	•	•	•	•				
26	•	•	•	•	•	•				
28	•	•	•	•	•	•	•			
30	•	•	•	•	•	•	•	•		
32	•	•	•	•	•	•	•	•	•	
34	•	•	•	•	•	•	•	•	•	•
36	•	•	•	•	•	•	•	•	•	•
38	•	•	•	•	•	•	•	•	•	•
40	•	•	•	•	•	•	•	•	•	•
42	•	•	•	•	•	•	•	•	•	•
44	•	•	•	•	•	•	•	•	•	•
46		•	•	•	•	•	•	•	•	•
48			•	•	•	•	•	•	•	•
50						•	•	•	•	•

### Interlocking Application

Verify proper alignment by inserting the 5.0mm Femoral Drill Bushing into the 8.0mm Femoral Screw Bushing; then, insert the two nested bushings through the interlocking hole. Insert the 5.0mm Drill Bit through the interlocking hole. When the device is properly aligned, the drill will pass through the proximal hole of the nail and will not contact the nail (Fig. 17).

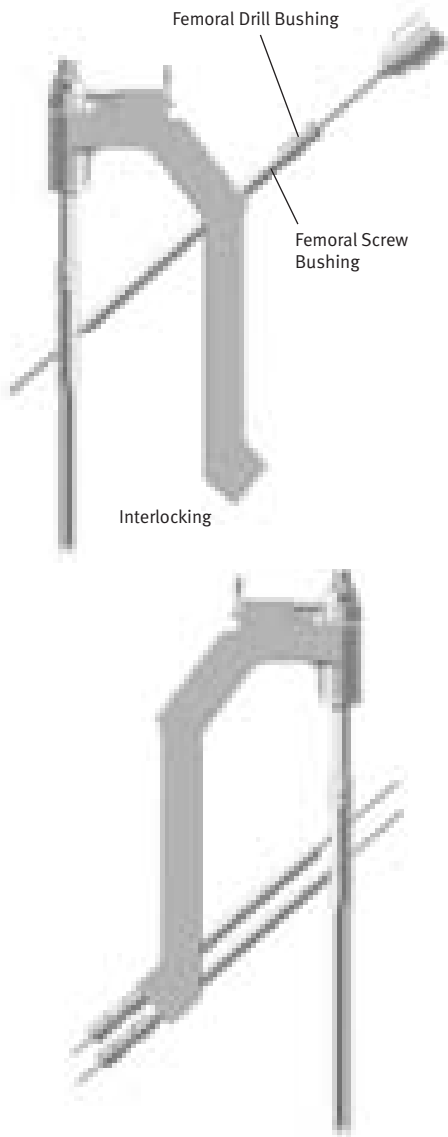

Fig 17

Place the selected nail over the Ball-Tip Guide Wire and into the femur. Screw the Threaded Driver or Slaphammer onto the back end of the Locking Bolt. Begin seating the nail using gentle impaction (Fig. 18). The mallet can be used with the threaded driver to make slight adjustments in depth. While impacting the nail, use the Femoral Proximal Guide to maintain the proper rotation during impaction. Be careful when crossing the fracture site.

### Recon Application

Verify proper alignment by inserting the 3.2mm Femoral Pin/Drill Bushing into the 5.0mm Femoral Drill Bushing; then, insert these two nested bushings into the 8.0mm Femoral Screw Bushing. Place the three nested guide bushings through one of the recon holes in the Femoral Proximal Guide. Insert the 3.2mm, 14-inch Steinmann Pin through the inner bushing. When the device is properly aligned, the Steinmann Pin will pass through the proximal hole of the nail and will not contact the nail.

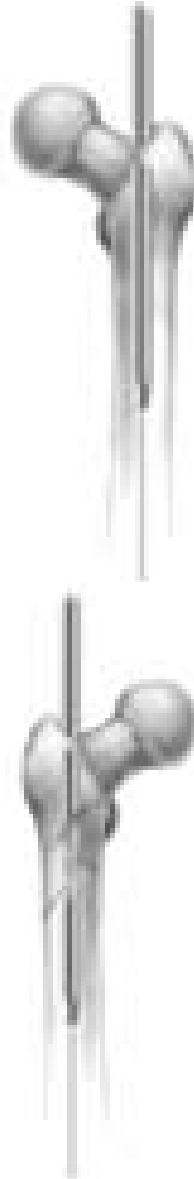

Fig 18

When performing the recon procedure, slide a 14-inch Steinmann Pin percutaneously along the anterior aspect of the trochanter parallel to the femoral neck. Verify pin placement with the C-arm (Fig. 19). This will help to identify the anteversion of the neck. During insertion, the Femoral Proximal Guide must remain parallel to this pin to ensure proper anteversion for the locking screws.

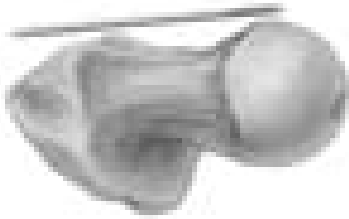

Fig 19

Take great care when crossing the fracture site. Visualize the fracture in two planes with image intensification to assure proper passage of the nail into the distal fragment. Reduce the force of impaction as the proximal end of the nail approaches the greater trochanter.

If excessive resistance is encountered during nail driving, remove the nail and check the size of both the reamer and nail. Once proper sizing has been confirmed, the surgeon may choose to over ream the canal further or select a smaller size nail.

Continue to seat the nail until it is flush with the trochanter. When the nail is fully seated, **REMOVE THE GUIDE WIRE** so it does not get trapped in the bone. Remember, it might be concealed inside the driver or Slaphammer.

### Proximal Locking

#### Interlocking Application

Insert the 8.0mm Femoral Screw Bushing through the Femoral Proximal Guide (Fig. 20). Then insert the 5.0mm Femoral Drill Bushing (Color Code: Green) (Table 2), which screws into the Femoral Screw Bushing. Insert the 5.0mm Femoral Drill (Color Code: Green) and drill until the medial cortex is penetrated (Fig. 21). Remove the drill and Femoral Drill Bushing.



Fig 20



Fig 21

Table 2. Implant / Instrumentation Specifications for Femoral Nails

Nail Diameter (mm)	8	9	10	11	12	13	14	15	16
Head Diameter (mm)	12	12	13	13	13	13	14	15	16
Guide Wire, Smooth (mm)	3.0	3.0	3.0	3.0	3.0	3.0	3.0	3.0	3.0
Proximal Screw Size (mm)	5.5	5.5	5.5	5.5	5.5	5.5	5.5	5.5	5.5
	green	green	green	green	green	green	green	green	green
Drill Bushing Size (mm)	5.0	5.0	5.0	5.0	5.0	5.0	5.0	5.0	5.0
Proximal Drill Size (mm)	5.0	5.0	5.0	5.0	5.0	5.0	5.0	5.0	5.0
Distal Screw Size (mm)	3.7	4.2/4.5	4.2/4.5	4.2/4.5	5.5	5.5	5.5	5.5	5.5
	yellow	blue	blue	blue	green	green	green	green	green
Trocar Diameter (mm)	3.2	3.7	3.7	3.7	5.0	5.0	5.0	5.0	5.0
Distal Drill Size (mm)	3.2	3.7	3.7	3.7	5.0	5.0	5.0	5.0	5.0

Use the Proximal Screw Depth Gauge to determine screw length (Fig. 22). Then use the T-Handle Screwdriver to insert the appropriate length 5.5mm screw (Color Code: Green) to the correct hash mark (Fig. 23). Then use the C-arm to check the position of the screw and tighten it appropriately.

Remove the screwdriver and Femoral Screw Bushing. Take A/P and lateral C-arm views to check for correct positioning. Disengage the ratchet mechanism, then loosen and remove the Locking Bolt and the Femoral Proximal Guide.

**NOTE: 5.5mm screws (Color Code: Green) are used proximally for all Femoral Nails. 3.7mm screws (Color Code: Yellow) are used distally for all 8mm Femoral Nails. 4.2 or 4.5mm screws (Color Code: Blue) are used distally for all 9mm-11mm Femoral Nails. 5.5mm screws (Color Code: Green) are used distally for all 12mm-16mm Femoral Nails.**



Fig 22



Fig 23

### Recon Application

Correct rotation of the nail is imperative for retrograde insertion of the two screws through the nail and into the femur for the recon procedure. Be sure that the nail is inserted to the correct depth to allow placement of both screws with the correct anteversion.

Insert the three nested guide bushings through the inferior recon hole of the Femoral Proximal Guide to the level of the skin. Make an incision in the skin and fascia at this point and continue to insert the bushings until contact is made with the lateral femoral cortex. Drill a 14-inch Steinmann Pin into the femoral head to the required level to achieve fracture fragment stability without penetrating the femoral head cortex. **Verify the proper position and anteversion of the pin with A/P and lateral C-arm views. Avoid excessive twisting or torquing of the Femoral Guide to ensure proper targeting.**

The Femoral Proximal Guide is radiolucent so it will not block the lateral view. If the position is not correct, remove the pin and adjust the nail rotation and/or nail depth. Then verify the new pin placement with the C-arm.

Now place the second set of three nested guide bushings into the superior hole of the Femoral Proximal Guide. Drill the second 14-inch Steinmann Pin in and verify its position with the C-arm (Fig. 24). If the position is unacceptable, remove both Steinmann Pins and reposition the nail. If correct position is obtained, remove the Threaded Driver or Slaphammer. Then remove the inferior Steinmann Pin and 3.2mm Proximal Pin/Drill Bushing.

Insert the 5.0mm Femoral Drill (Color Code: Green) into the 5.0mm Femoral Drill Bushing (Color Code: Green). Drill the inferior proximal screw hole while monitoring image intensification to prevent penetration of the femoral head (Fig. 25). Read the proper screw length directly from the calibrated Femoral Drill (Fig. 26). Remove the 5.0mm drill and Femoral Drill Bushing.

Insert the Recon Screw Counterbore through the outer 8.0mm Femoral Screw Bushing and counterbore (Fig. 27). The blunt end of the counterbore serves as a stop.

Screw length may alternatively be measured using the Proximal Screw Depth Gauge. Select a screw equal to the measured length to avoid penetration of the joint.



Fig 24

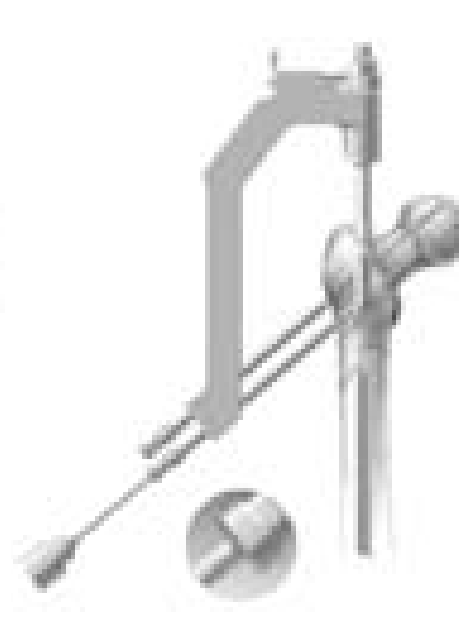

Fig 26



Fig 25

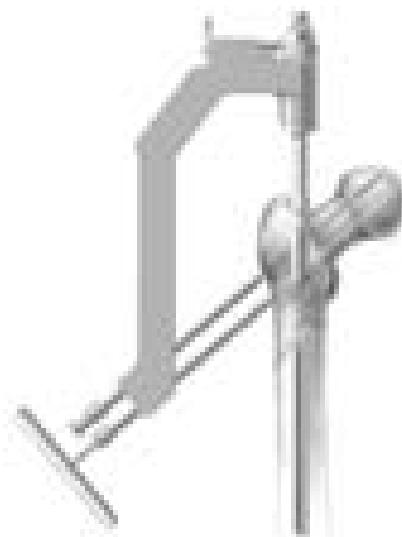

Fig 27

Another gauge that can be used to measure screw length is the Cannulated Depth Gauge. Slide the Cannulated Depth Gauge over the Steinmann Pin, i.e., the inferior of the two Steinmann Pins if two pins are used, until the gauge contacts the lateral aspect of the femur. Assess that the gauge is seated against the bone using the C-arm. Read and record the length of the Steinmann Pin from the calibrations on the depth gauge.

**NOTE: This measurement designates the correct length of the screw to be implanted.**

Remove the counterbore. Insert the appropriate length 5.5mm partially threaded Recon Screw through the outer bushing to the correct hash mark using the T-Handle Screwdriver (Fig. 28). Use the C-arm to ensure proper seating of the locking screw well within the femoral head. Tighten it appropriately.



Fig 28

The first screw should lie in the inferior neck to allow room for the second screw to be placed. This may be difficult in small patients or patients

with varus hips. Be certain to get the inferior screw tight against the medial cortex to prevent varus deformity and allow for insertion of the proximal screw.

Remove the T-Handle Screwdriver and Femoral Screw Bushing. Take A/P and lateral C-arm views to check for correct positioning. Repeat the same procedures for insertion of the superior locking screw (Fig. 29). Again, observe A/P and lateral C-arm views to ensure proper seating within the femoral head and neck. Disengage the ratchet mechanism, then loosen and remove the Locking Bolt and Femoral Proximal Guide.



Fig 29

**NOTE: 5.5mm recon screws (Color Code: Candy Stripe Green) are used proximally for the recon procedure. 3.7mm screws (Color Code: Yellow) are used distally for all 8mm Femoral Nails. 4.2 or 4.5mm screws (Color Code: Blue) are used distally for all 9mm-11mm Femoral Nails. 5.5mm screws (Color Code: Green) are used distally for all 12mm-16mm Femoral Nails.**

## End Cap Placement

Insert an *M/DN* End Cap of the appropriate length (0mm, 5mm, 10mm, 15mm) in the proximal nail. These caps help protect the internal threads of the nail, facilitate future extraction, and allow the surgeon to adjust the length of the nail.

## Distal Locking

### Technique for Using the Freehand Targeting Device

The distal locking screws may be inserted with a freehand technique using the Freehand Targeting Device. Insert an appropriate size Trocar [3.2mm (Color Code: Yellow) for 3.7mm screw, 3.7mm (Color Code: Blue) for 4.2mm or 4.5mm screw, 5.0mm (Color Code: Green) for 5.5mm screw] (Fig. 30) into the Freehand Targeting Device. Finger tighten the set screw.

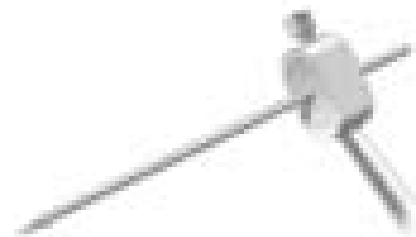

Fig 30

Choose the appropriate locking hole based on the need for dynamization. The superior locking hole on the *M/DN* Nail is used for static locking, while the distal locking hole is used for dynamic locking. If static locking is preferred, but there is a potential need for later dynamization, insert screws in both locking holes. The locking screw in the static hole can then be removed to achieve later dynamization.

For success with this technique, proper placement of the lateral x-ray beam is critical. Position the C-arm so the locking hole of the nail appears perfectly round on the monitor (Fig. 31).

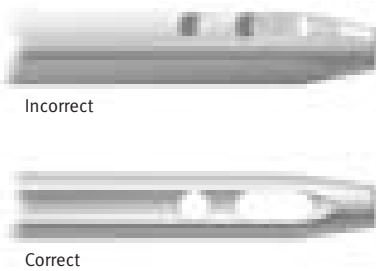

Fig 31

When this is achieved, bring the tip of the Trocar to the skin and use the C-arm to center it over the hole. Make a lateral stab wound opposite the appropriate locking hole, and dissect down to bone. Bring the tip of the Trocar to the bone and center it over the locking hole using the C-arm (Fig. 32a).

Align the Trocar with the axis of the x-ray beam (Fig. 32b and c). Drive the Trocar into the bone and across the hole in the nail in line with the lateral x-ray beam, but do not penetrate the medial cortex.

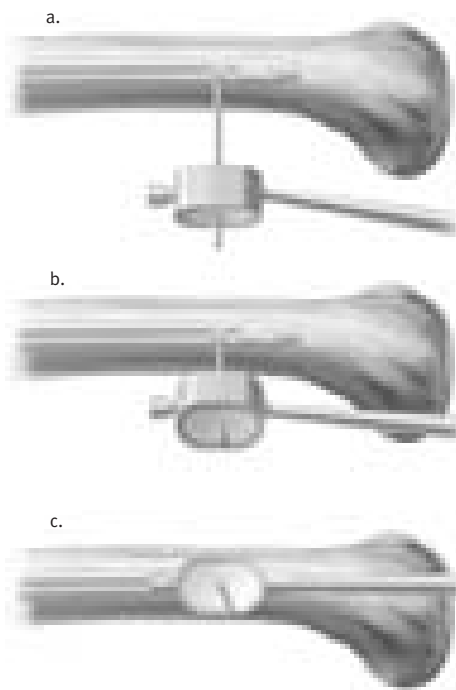

Fig 32

Remove the Targeting Device by loosening the set screw. Verify Trocar placement in both the A/P and lateral planes (Fig. 33).

After it has been correctly placed, remove the Trocar. The path of the Trocar in the bone acts as a pilot hole for the appropriate size drill (Fig. 34). Attach the appropriate drill (same size as the Trocar) to the Freehand Targeting Device. Insert the drill into the pilot hole made by the Trocar. Before drilling through the medial cortex, check the A/P and lateral C-arm image to assure that the drill is in the hole in the nail. Then drill through the medial cortex.

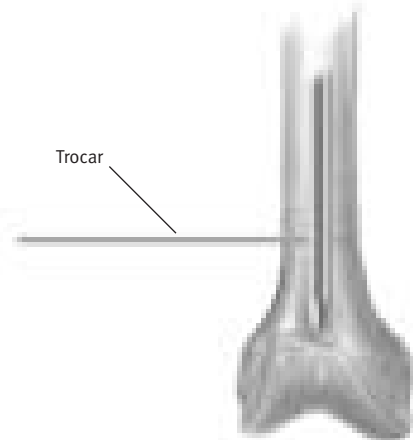

Fig 33

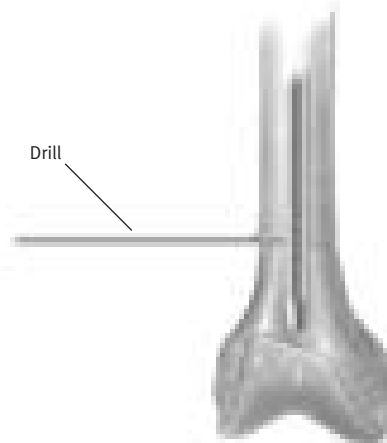

Fig 34

Remove the drill and insert the Distal Screw Depth Gauge (Fig. 35). The length of the screw is determined by reading it directly off the Distal Screw Depth Gauge. Select an appropriate length screw to ensure adequate engagement of the medial cortex. Insert the appropriate size *M/DN* Screw using the Distal Screwdriver (Fig. 36) (Table 2).

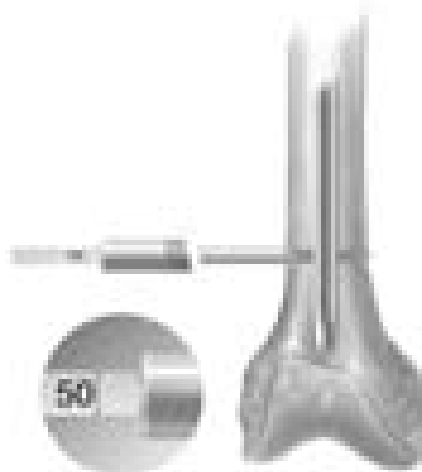

Fig 35

If desired, insert the second screw in the second locking hole of the nail in an identical manner (Fig. 37). Check the position of both screws with the C-arm in the A/P and lateral planes (Fig. 38).

Table 2. Distal Screw Sizes for *M/DN* Femoral Recon Nails

Nail Diameter (mm)	Screw Diameter		
	Distal 3.7mm Cortical	Distal 4.2/4.5mm Cortical	Distal 5.5mm Cortical
8	•		
9		•	
10		•	
11		•	
12			•
13			•
14			•
15			•
16			•

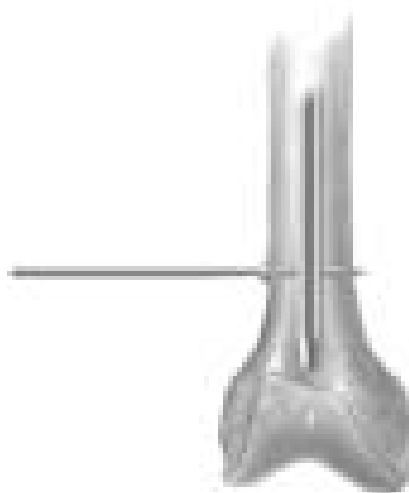

Fig 36

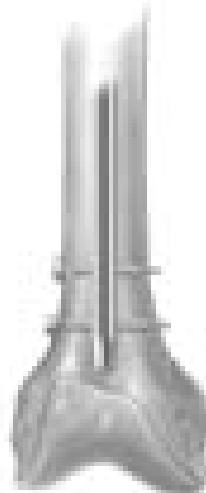

Fig 37



Fig 38

Bushings are available that can be used with the Freehand Targeting Device. A separate radiolucent Bushing Insert is available to aid in targeting.

### Closure and Postoperative Care

Close the proximal wound over suction drains, and apply a soft compression dressing.

### Extraction

Should extraction of the nail become necessary, attach the Threaded Extractor to the end of the nail and use the Slaphammer to extract the nail (Fig. 39).

**NOTE: The cannulated Locking Bolt should not be used for nail removal. Extraction of the nail should be accomplished by using the Threaded Extractor.**



Fig 39

## Instrument Case Options

### M/DN Instruments

Set Number 00-2255-000-15  
(includes plastic case/trays/lid & instruments)

Prod. No.	Description	
00-2241-001-00	M/DN R-F Targeting Guide	1
00-2241-001-01	M/DN Adjustable Target Arm	1
00-2241-005-00	M/DN Nut Counterbore	1
00-2241-006-00	M/DN Cortical Nut Screwdriver	1
00-2241-008-37	M/DN R-T Bushing 3.7mm	2
00-2241-008-50	M/DN R-T Bushing 5.0mm	2
00-2246-023-00	Guide Pin 3.2mm Dia X 304.8mm	2
00-2246-063-01	Offset Driver Adaptor	1
00-2246-063-05	Adaptor Converter	1
00-2255-001-00	M/DN Locking Bolt	3
00-2255-002-00	M/DN Prox Targeting Guide Femoral	1
00-2255-003-00	M/DN Prox Targeting Guide Tibial	1
00-2255-003-01	M/DN Tibial Oblique Hole Adapter	1
00-2255-004-00	M/DN Prox Targeting Guide Humeral	1
00-2255-004-01	M/DN Oblique Hole Adapter Humeral	1
00-2255-005-32	M/DN Fem Pin/Drill Bushing 3.2mm	2
00-2255-005-50	M/DN Femoral Drill Bushing 5.0mm	2
00-2255-005-80	M/DN Fem Screw Bushing 8.0mm	4
00-2255-006-37	M/DN Tib/Hum Drill Bushing 3.7mm	1
00-2255-006-80	M/DN Tib/Hum Screw Bushing 8.0mm	1
00-2255-007-37	M/DN Bushing Awl 3.7mm Dia	1
00-2255-007-50	M/DN Bushing Awl 5.0mm Dia	2
00-2255-011-00	M/DN Recon Screw Counter Bore	1
00-2255-028-00	M/DN $\frac{9}{16}$ in. Pin Wrench	3
00-2255-031-37	Retrograde Femoral Drill, 3.7mm	1
00-2255-032-37	Tibial/Humeral Drill, 3.7mm	1
00-2255-035-50	M/DN Femoral Drill Large 5.0mm	2
00-2255-070-00	Fem/Tib/Hum/Retro Inst Case (includes plastic case/trays & lid)	1

\* The 7mm Straight Awl (00-2237-001-07) OR the 7mm Angled Femoral Awl (00-2255-016-00) will fit in the case. However, when you order the set number (00-2255-000-16), you will get the Angled Awl.

**NOTE: See sales representative for optional instruments.**

### General Instruments

Set Number 00-2255-000-11  
(includes plastic case/trays/lid & instruments)

Prod. No.	Description	
00-0187-004-59	Steinmann Pins, Style 5, 3.2mm Dia X 229mm	1
00-2228-097-00	Pressure Sentinel Diameter Gauge	1
00-2237-001-07	Femoral Awl, 7mm	1
00-2237-005-00	Mallet 3 lb.	1
00-2237-008-00	Skin Protector	1
00-2237-042-00	Threaded Driver	1
00-2237-044-00	Trochanteric Reamer, 9mm	1
00-2237-046-00	Reduction Rod	1
00-2237-048-00	Flared Exchange Tube	1
00-2237-053-00	Wire Grip T-Handle	1
00-2237-054-00	Screw Depth Gauge	1
00-2237-055-00	Ruler	1
00-2239-001-00	Tibial Awl	1
00-2241-002-37	M/DN Proximal Bushing 3.7mm	1
00-2241-002-50	M/DN Proximal Bushing 5.0mm	1
00-2241-002-80	M/DN Proximal Bushing 8.0mm	1
00-2241-012-37	Pilot Tip Prox Stop Drill 3.7mm	1
00-2241-012-50	Pilot Tip Prox Stop Drill 5.0mm	1
00-2246-062-00	Reversed Tibial Awl	1
00-2255-009-00	Slaphammer	1
00-2255-012-33	M/DN Distal Trocar 3.2mm	1
00-2255-012-37	M/DN Distal Trocar 3.7mm	1
00-2255-012-50	M/DN Distal Trocar 5.0mm	1
00-2255-013-00	M/DN T-Handle HXHD Screwdriver 3.5mm	1
00-2255-013-01	M/DN Distal Screwdriver 3.5mm Hex	1
00-2255-014-00	M/DN Threaded Extractor	2
00-2255-015-01	M/DN Distal Insert	1
00-2255-015-02	M/DN Set Screw	1
00-2255-015-03	M/DN Handle	1
00-2255-015-04	M/DN Bushing Insert	1
00-2255-016-00	M/DN Fem Awl 7mm Dia Angled Tip	1
00-2255-017-00	M/DN Flared Exchange Tube 8mm	1
00-2255-018-00	M/DN Distal Screw Depth Gauge	1
00-2255-020-00	M/DN T-Handle Ratchet Screwdriver	1
00-2255-027-00	M/DN Locking Bolt Wrench	1
00-2255-033-32	Pilot Tip Distal Drill, 3.2mm	1
00-2255-033-37	Pilot Tip Distal Drill, 3.7mm	1
00-2255-033-50	Pilot Tip Distal Drill, 5.0mm	1
00-2255-065-00	General Instrument Case (includes plastic case/trays & lid)	1

### Pressure Sentinel Intramedullary Reaming System Order Information

Prod. No.	Description
<b>00-2218-000-00</b>	<b>Long Pressure Sentinel Reamers Tray/Case/Lid</b>
Includes the following instruments & case:	
00-2218-008-00	8.0mm Long Flexible PS Reamer
00-2218-008-05	8.5mm Long Flexible PS Reamer
00-2218-009-00	9.0mm Long Flexible PS Reamer
00-2218-009-05	9.5mm Long Flexible PS Reamer
00-2218-010-00	10.0mm Long Flexible PS Reamer
00-2218-010-05	10.5mm Long Flexible PS Reamer
00-2218-011-00	11.0mm Long Flexible PS Reamer
00-2218-011-05	11.5mm Long Flexible PS Reamer
00-2218-012-00	12.0mm Long Flexible PS Reamer
00-2218-012-05	12.5mm Long Flexible PS Reamer
00-2218-013-00	13.0mm Long Flexible PS Reamer
00-2218-013-05	13.5mm Long Flexible PS Reamer
00-2218-014-00	14.0mm Long Flexible PS Reamer
00-2218-014-05	14.5mm Long Flexible PS Reamer
00-2218-015-00	15.0mm Long Flexible PS Reamer
00-2218-015-05	15.5mm Long Flexible PS Reamer
00-2218-016-00	16.0mm Long Flexible PS Reamer
00-2218-016-05	16.5mm Long Flexible PS Reamer
00-2218-017-00	17.0mm Long Flexible PS Reamer
00-2218-017-05	17.5mm Long Flexible PS Reamer
00-2218-018-00	18.0mm Long Flexible PS Reamer
00-2228-030-00	T-Handle Extractor
00-2228-097-00	Diameter Gauge
00-5044-012-00	Adapter 3 Jaw Chuck
00-2228-098-10	Soak Tray
00-2218-025-00	Long Cleaning Brush*
00-2218-030-00	Torque Limiter
00-2237-075-00	Long Reamer/Instrument Case Assembly
00-2237-076-00	Long Reamer/Instrument Case Base
00-2237-077-00	Long Reamer/Instrument Case Lid
00-2237-078-00	Long Reamer/Instrument Top Tray (8mm-13.5mm)
00-2237-079-00	Long Reamer/Instrument Middle Tray

\*Non-sterile

### 00-2228-000-00 Pressure Sentinel Reamer Full Set Includes the following instruments & case:

00-2228-005-00	5.0mm Flexible Reamer
00-2228-005-05	5.5mm Flexible Reamer
00-2228-006-00	6.0mm Flexible Reamer
00-2228-006-05	6.5mm Flexible Reamer
00-2228-007-00	7.0mm Flexible Reamer
00-2228-007-05	7.5mm Flexible Reamer
00-2228-008-00	8.0mm Flexible Reamer
00-2228-008-05	8.5mm Flexible Reamer
00-2228-009-00	9.0mm Flexible Reamer
00-2228-009-05	9.5mm Flexible Reamer
00-2228-010-00	10.0mm Flexible Reamer
00-2228-010-05	10.5mm Flexible Reamer
00-2228-011-00	11.0mm Flexible Reamer
00-2228-011-05	11.5mm Flexible Reamer
00-2228-012-00	12.0mm Flexible Reamer
00-2228-012-05	12.5mm Flexible Reamer
00-2228-013-00	13.0mm Flexible Reamer
00-2228-013-05	13.5mm Flexible Reamer
00-2228-014-00	14.0mm Flexible Reamer
00-2228-014-05	14.5mm Flexible Reamer
00-2228-015-00	15.0mm Flexible Reamer
00-2228-015-05	15.5mm Flexible Reamer
00-2228-016-00	16.0mm Flexible Reamer
00-2228-016-05	16.5mm Flexible Reamer
00-2228-017-00	17.0mm Flexible Reamer
00-2228-017-05	17.5mm Flexible Reamer
00-2228-018-00	18.0mm Flexible Reamer
00-2228-018-05	18.5mm Flexible Reamer
00-2228-019-00	19.0mm Flexible Reamer
00-2228-019-05	19.5mm Flexible Reamer
00-2228-020-00	20.0mm Flexible Reamer
00-2228-020-05	20.5mm Flexible Reamer
00-2228-021-00	21.0mm Flexible Reamer
00-2228-021-05	21.5mm Flexible Reamer
00-2228-022-00	22.0mm Flexible Reamer
00-2228-030-00	T-Handle Extractor
00-2228-097-00	Diameter Gauge
00-2228-098-00	Soak Tray
00-5044-012-00	<sup>1</sup> / <sub>4</sub> in. Jacob's Chuck to Zimmer Adapter, Qty=2
00-2228-090-00	Sterilization Case

**Optional Reamer Sizes**

Prod. No.	Description
00-2228-022-05	22.5mm Flexible Reamer
00-2228-023-00	23.0mm Flexible Reamer
00-2228-023-05	23.5mm Flexible Reamer
00-2228-024-01	24.0mm Flexible Reamer
00-2228-024-05	24.5mm Flexible Reamer
00-2228-025-01	25.0mm Flexible Reamer
00-2228-025-05	25.5mm Flexible Reamer
00-2228-026-01	26.0mm Flexible Reamer
00-2228-026-05	26.5mm Flexible Reamer
00-2228-027-01	27.0mm Flexible Reamer

**Pressure Sentinel Sets**

Prod. No.	Description
<b>00-2228-000-01</b>	<b>Pressure Sentinel Reamer Trauma Set</b> Includes the following instruments & case: 5.0mm, 6.0mm, 7.0mm & 8.00mm-17.5mm Flexible Reamers in .5mm increments (1 ea.)
00-2228-030-00	T-Handle Extractor
00-5044-012-00	1/4 in. Jacob's Chuck to Zimmer Adapter, Qty=2
00-2228-090-00	Sterilization Case
<b>00-2228-000-02</b>	<b>Pressure Sentinel Reamer Hip Set</b> Includes the following instruments & case: 8.0mm-18.0mm Flexible reamers in 1mm increments (1 ea.)
00-2228-030-00	T-Handle Extractor
00-5044-012-00	1/4 in. Jacob's Chuck to Zimmer Adapter, Qty=1
00-2228-090-00	Sterilization Case

<b>00-2228-000-03</b>	<b>Pressure Sentinel Reamer Expanded Hip Set</b> Includes the following instruments & case: 8.0mm-18.0mm Flexible reamers in .5mm increments (1 ea.)
00-2228-030-00	T-Handle Extractor
00-5044-012-00	1/4 in. Jacob's Chuck to Zimmer Adapter, Qty=1
00-2228-090-00	Sterilization case
<b>00-2228-90-00</b>	<b>Sterilization Case</b> Includes the following components:
00-2228-091-00	Base
00-2228-092-00	18.0mm to 22.0mm Reamer Tray
00-2228-093-00	12.0mm to 17.5mm Reamer Tray
00-2228-094-00	5.0mm to 11.5mm Reamer Tray
00-2228-096-00	Case Lid

<b>00-9975-011-00</b>	<b>Pressure Sentinel Reamer ZMR® Set</b> Includes the following components: 8.0mm-27.0mm Flexible reamers in .5mm increments (1 ea.)
00-9965-081-10	ZMR Flexible Reamer Diameter Gauge
00-9975-099-00	Case Lid
00-2228-040-00	ZMR Flexible Reamer Metal Case
* Set includes case and contents without the 00-9975-099-00 Case Lid. The Case Lid must be ordered separately.	

**Optional Instruments**

Prod. No.	Description
00-2255-008-00	Guide Wire 2.4mm, Ball-Tip, 70cm box (required for 5.0mm-7.5mm Pressure Sentinel Reamers)
47-2255-008-01	Guide Wire 3.0mm, Ball-Tip, 100cm Sterile/box (required for 8.0mm and larger Pressure Sentinel Reamers)
00-2255-008-00	Guide Wire 3.0mm, Ball-Tip, 100cm box (required for 8.0mm and larger Pressure Sentinel Reamers)



This documentation is intended exclusively for physicians and is not intended for laypersons. Information on the products and procedures contained in this document is of a general nature and does not represent and does not constitute medical advice or recommendations. Because this information does not purport to constitute any diagnostic or therapeutic statement with regard to any individual medical case, each patient must be examined and advised individually, and this document does not replace the need for such examination and/or advice in whole or in part. Please refer to the package inserts for important product information, including, but not limited to, contraindications, warnings, precautions, and adverse effects.



Contact your Zimmer representative or visit us at [www.zimmer.com](http://www.zimmer.com)

The CE mark is valid only if it is also printed on the product label.

